



Operation Manual

v.1.0

Compact Line 2- Headend Series



SCL - 424CT / 434CT

4x DVB-S/S2/T/T2/C + 4xFlexCAM to 4x DVB-T/C + IP
4x DVB-S/S2/S2X + 4xFlexCAM to 4x DVB-T/C + IP



Contents

Important safety precautions information	p. 3
Introduction	p. 5
Installation	p. 10
Technical specifications	p. 34
Warranty	p. 41
Notes	p. 43

1. IMPORTANT SAFETY PRECAUTIONS INFORMATION

READ AND UNDERSTAND THE FOLLOWING WARNINGS BEFORE USING YOUR DEVICE TO ENSURE SAFE AND PROPER USAGE

WARNING

To prevent fire, electric shock, or other hazards, always observe the following safety precautions. These precautions include, but are not limited to:

Power supply / Mains cord

- Use the unit strictly within the voltage range specified by the manufacturer to prevent damage or malfunction.
- Regularly inspect the power connector and remove any accumulated dirt or dust to maintain optimal performance.
- Use only the mains cord provided with your unit to ensure compatibility and safety.
- Avoid using the unit or plugging in the mains cord if it appears damaged, frayed, or compromised in any way.
- Keep the mains cord away from heat sources and avoid pulling, placing heavy objects on, or causing damage to the cord. Store it safely out of children's reach.
- Plug the device into a properly grounded socket to minimize the risk of electrocution.
- When disconnecting plugs, always pull on the plug and not the cord. Ensure the unit's power switch is off before removing the cord from an outlet.
- Unplug the mains cord during extended periods of non-use or during storms to protect the unit.
- Avoid connecting the unit to a multi-outlet to prevent plug overheating and potential fire hazards.

Disassemblin

- This unit contains specialized components that are not user serviceable. Refrain from disassembling or attempting repairs, as this will void any warranties. Contact the manufacturer for assistance with any issues.

Water/humidity

- Store and operate the unit in a dry environment, away from moisture or water sources.
- Never plug or unplug the unit with wet hands to avoid electric shock.

Fire

- Avoid placing open flames, such as candles, on or near the unit to prevent potential fires.
- In case of damaged mains cords, power connectors, sudden loss of functionality, unusual smells, or smoke, promptly turn off the unit, disconnect the mains cord, and contact the manufacturer's technical support department.

Installation / Storage

- To ensure optimal performance and prevent damage, store the unit in a clean, dry location, away from temperature extremes (e.g., direct sunlight, heaters, or inside a car during the day). Securely place the unit to prevent falls.
- Before moving the unit, disconnect all cords.
- When installing the unit, ensure that an outlet is easily accessible for quick disconnection in case of malfunction. Disconnect the mains cord when the unit is not in use for extended periods.

Connectivity

- Always turn off and unplug all devices before connecting the unit to other electronic devices.

Maintenance

- Avoid spilling liquids on the unit. To clean, use a soft, slightly damp cloth and allow the unit to dry completely before using it again. Do not use harsh chemicals or volatile liquids.

Handling

- Do not insert fingers or objects into the unit's openings.
- Never insert paper, metal, or other foreign objects into the unit's openings. If foreign objects are suspected inside the unit, turn it off, unplug the mains cord, and contact the manufacturer's technical support department.
- Refrain from stepping on or placing heavy objects on the unit. Gently handle all buttons, connectors, and switches to avoid hardware damage.

Electromagnetic Interference (EMI) and Radio Frequency Interference (RFI) precautions

- Be aware that your device may cause or be affected by electromagnetic interference or radio frequency interference. Keep the device at a safe distance from other electronic devices, such as pacemakers, hearing aids, or other medical equipment, to prevent potential interference.
- Avoid placing the device near or on top of audio equipment or televisions, as it may cause interference with the reception or operation of these devices.

Accessory compatibility

- Use only compatible accessories and attachments approved by the manufacturer. Using unauthorized or incompatible accessories may cause malfunction, damage to the unit, or pose safety risks.

Software updates

- Regularly check for software updates and install them to ensure your device stays up to date with the latest security patches and bug fixes. This will help maintain the device's performance, stability, and overall user experience.

Child safety

- Keep the device and all its accessories out of the reach of children. Small parts may pose a choking hazard. Additionally, improper use of the device by children could result in damage or injury.

Environment and disposal

- Recycle or dispose of the device, its accessories, and batteries according to local regulations. Electronic devices and batteries should not be disposed of in regular household waste to prevent environmental harm.

Emergency situations

- Be aware that in certain emergency situations, such as earthquakes, fires, or power outages, the device may not function as expected. Always have alternative communication methods and emergency plans in place.

Grounding Precaution

Proper grounding is crucial for the safe and effective operation of your device. To minimize the risk of electric shock, equipment damage, or interference, please follow these grounding precautions:

- Ensure the device is connected to a grounded electrical outlet: The device should be connected to a properly grounded, three-pronged electrical outlet. This will help to protect the device and users from potential electrical hazards.
- Check the grounding of your entire system: All interconnected devices, such as antennas, cables, and other equipment, should also be properly grounded. This helps prevent ground loops, which can cause interference and degrade system performance.
- Use grounded cables and connectors: When connecting the device to other devices, use shielded cables and connectors with proper grounding. This ensures that the entire signal path is grounded, reducing the potential for interference, and improving overall system performance.
- Inspect grounding connections periodically: Regularly check all grounding connections for signs of wear, damage, or corrosion. Loose or damaged grounding connections can compromise the safety and performance of your DTV headend system.
- Consult a professional if in doubt: If you are unsure about the grounding of your system or require assistance with grounding-related issues, consult a qualified technician or electrician. Proper grounding is essential for the safe and effective operation of your device and the overall DTV headend system.

By taking these additional safety precautions into consideration, you can further ensure the safe and proper use of your device.

2. INTRO

Congratulations on purchasing the SCL- 424CT / 434CT You are now the proud owner of a high-quality, professional DTV headend. This powerful and versatile device is designed to provide you with exceptional performance and reliability for all your digital television needs.

3. INSTRUCTIONS

3.1 - DESCRIPTION

The SCL-424CT and SCL-434CT are part of the Compact Line 2 headends product line that provides Free-To-Air (FTA) models with advanced flexibility. These models offer TV distribution signal over RF+IP simultaneously for seamless integration with a wide range of applications. This feature-rich series is designed to meet the evolving needs of the broadcasting industry and offer a superior viewing experience to the end-users.

(For SCL-424CT model)

The SCL-424CT headend from Lemco's Compact Line 2 series is an advanced and powerful all-in-one device, designed to meet diverse broadcasting requirements. Capable of receiving up to 4 independent satellite (DVB-S/S2), terrestrial (DVB-T/T2), or cable (DVB-C) signals, it converts them into 4 DVB-T/C RF output channels while simultaneously providing 1 Gbit IPTV streaming.

Featuring 4 CI interfaces with FlexCAM technology, the SCL-424CT can descramble various TV content using the appropriate CAM (Conditional Access Module). Its innovative "pool" technology allows users to select any program from the 4 inputs and assign it to any of the 4 RF + IP outputs, ensuring exceptional flexibility in content distribution. Powered by a robust CPU (Quad-core @ 1.8GHz / 2GB RAM) and operating on Linux OS, the SCL-424CT guarantees efficient device control and offers a user-friendly, highly responsive interface. Additionally, the device can be managed remotely or locally via Ethernet. With its compact design and impressive features, the SCL-424CT is an ideal solution for distributing Free-To-Air (FTA) TV programs from various sources (satellite, terrestrial, or cable) to a CATV installation using DVB-T/C and IP technology.

Furthermore, the SCL-424CT can host an IPTV middleware (Fleex Embedded) without requiring an external server, allowing users to control all TV monitors in an installation (compatible with LG, Samsung, Philips, and custom STBs). This provides a wide range of features, including Live TV, Live Radio, Info channels, Cast, Weather, Alarm, EPG, and more.

Overall, the SCL-424CT headend is a sophisticated and versatile device that delivers top-quality TV distribution, making it an excellent choice for cable TV companies, IPTV providers, hotels, hospitals, and other similar installations.

(For SCL-434CT model)

The SCL-434CT headend from Lemco's Compact Line 2 series is a highly versatile and efficient all-in-one device designed to accommodate diverse broadcasting needs. Its advanced capabilities include the ability to receive up to 4 independent signals from satellite (DVB-S/S2/S2X) with multi-stream support, converting them into 4 DVB-T/C RF output channels while simultaneously offering 1 Gbit IPTV streaming.

Featuring 4 CI interfaces with FlexCAM technology, the SCL-434CT can descramble various TV content using the appropriate CAM (Conditional Access Module). Its innovative "pool" technology allows users to select any program from the 4 inputs and assign it to any of the 4 RF + IP outputs, ensuring exceptional flexibility in content distribution. Powered by a robust CPU (Quad-core @ 1.8GHz / 2GB RAM) and operating on Linux OS, the SCL-434CT guarantees efficient device control and offers a user-friendly, highly responsive interface. Additionally, the device can be managed remotely or locally via Ethernet. With its compact design and impressive features, the SCL-434CT is an ideal solution for distributing satellite TV programs from various sources to a CATV installation using DVB-T/C and IP technology.

Furthermore, the SCL-434CT can host an IPTV middleware (Fleex Embedded) without requiring an external server, allowing users to control all TV monitors in an installation (compatible with LG, Samsung, Philips, and custom STBs). This provides a wide range of features, including Live TV, Live Radio, Info channels, Cast, Weather, Alarm, EPG, and more.

Overall, the SCL-434CT headend is a sophisticated and versatile device that delivers top-quality TV distribution, making it an excellent choice for cable TV companies, IPTV providers, hotels, hospitals, and other similar installations.

3.2 - FEATURES

- 4 x independent multi-standard inputs DVB-S/S2/T/T2/C (For SCL-424CT)
- 4 x independent multi-standard inputs DVB-S/S2/S2X (For SCL-434CT)
- Multi-stream reception support (For SCL-434CT)
- 4x Common Interfaces (FlexCAM technology)
- 4 x RF output DVB-T/C (software selectable)
- MER value > 45dB
- IPTV streaming (up to 64 x SPTS / 4 x MPTS) @ 480Mbps
- SAP/SDP support
- "Pool" technology
- PID Filtering
- Custom NIT/SDT support
- PCR re-stamping, Correction
- EPG over RF and IP
- Very friendly user interface
- Fleex Embedded support (IPTV middleware)
- 5 year warranty

3.2.1 - Auto-reset functions and watchdog

During the normal operation of the SCL-424CT/434CT, the main CPU monitors all the internal parts in order to ensure that the device works normally. In case of an internal error or module failure, the SCL-424CT/434CT immediately initiates the recovery procedure by resetting the appropriate module or the device. Finally, watchdog timers ensure that the device will be reset in case of CPU failure.

3.2.2 - Multi-Standard inputs

Discover the exceptional versatility of the Compact Line 2 Multi-standard headend solution. This advanced system is specifically designed to accommodate diverse broadcasting needs and industry standards, including DVB-S/S2/S2X, DVB-T/T2, DVB-C and HDMI. Its seamless integration of various signal formats makes it the ideal choice for cable TV companies, IPTV providers, hotels, hospitals, and other installations that require a flexible and efficient headend solution.

3.2.3 - "Pool" technology

One of the most state-of-the-art TS multiplexer is responsible of providing the "pool" technology feature as well as to offer a variety of different features such as custom NIT/SDT creation, EPG over RF and IP, LCN and more...

3.2.4 - RF and IPTV distribution simultaneously

Experience the best of both worlds with the Compact Line 2 headend solution, which offers simultaneous RF and IPTV distribution. This cutting-edge system enables you to distribute content through both traditional coaxial infrastructure (RF) and modern internet protocol television (IPTV) networks, providing unparalleled flexibility and efficiency in content delivery.

3.2.5 - RF Matrix support

Use Compact Line 2 headend series to control up to 99 x TV monitors over any coaxial infrastructure by having the ability to change any TV channel (RFM-002 RF Matrix STB is required).

3.2.6 - FlexCAM technology

The FlexCAM technology supported by the SCL-424CT/434CT gives the opportunity to the user to connect each CI (Common Interface) independently either at the inputs of the device and before the multiplexer or at the four outputs of the multiplexer providing great flexibility depending on the installation scenario.

3.2.7 - Fleex Embedded support

Enhanced guest experience with Fleex Embedded IPTV middleware enabling control of TVs from major brands such as LG, Samsung, and Philips, and offering basic middleware functionality directly from the headend without the need for external server.

3.3 – Product views

3.3.1 – Front panel view



1. IP LAN & Fleex Embedded control
2. RF output
3. RF input
4. Reset button
5. Status LED
6. IP streaming output

3.3.1 – Back panel view



1. Power input
2. DVB-S/S2/S2X/T/T2/C inputs
3. Air ways
4. Common Interfaces

4. INSTALLATION

4.1 - General

The SCL-424CT/434CT headend solution offers a highly user-friendly interface for programming and monitoring purposes. To access the intuitive graphical user interface, simply open an internet browser, such as Internet Explorer, Firefox, or Chrome, and enter the following static IP address: 192.168.1.200. This easy-to-use interface provides an efficient way to manage and monitor your headend system, ensuring optimal performance and seamless content delivery.

Once connected to the SCL-424CT/434CT headend device, you will be prompted to log in, as shown in the provided image:

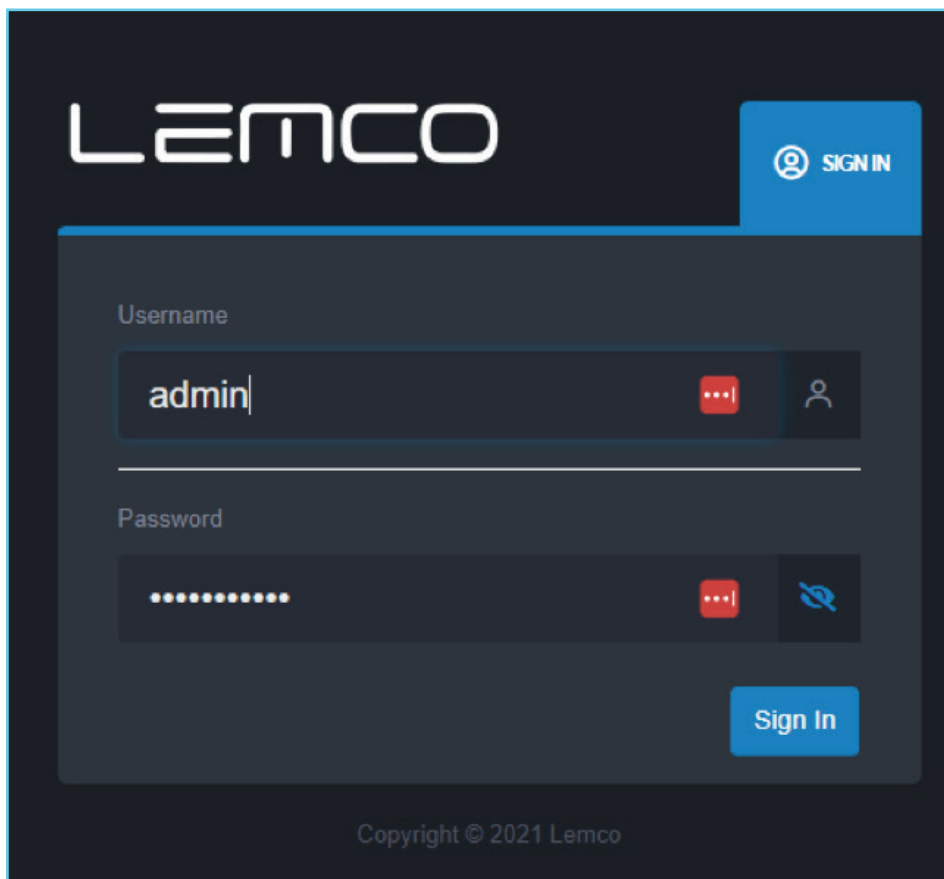

The default username and password for the device are as follows:

Username: admin
Password: 12345

Enter the default credentials to access the system's user interface, where you can manage and monitor your headend solution with ease.

4.2 – Graphical User Interface (GUI)

Status

4.2.1 - "Dashboard" page

Every time you connect to the SCL-424CT/434CT headend device, the "Dashboard" page is automatically loaded, providing a comprehensive overview of the device's current status. This dashboard presents essential information about the system's performance and operation, allowing you to monitor and manage your headend solution effectively.

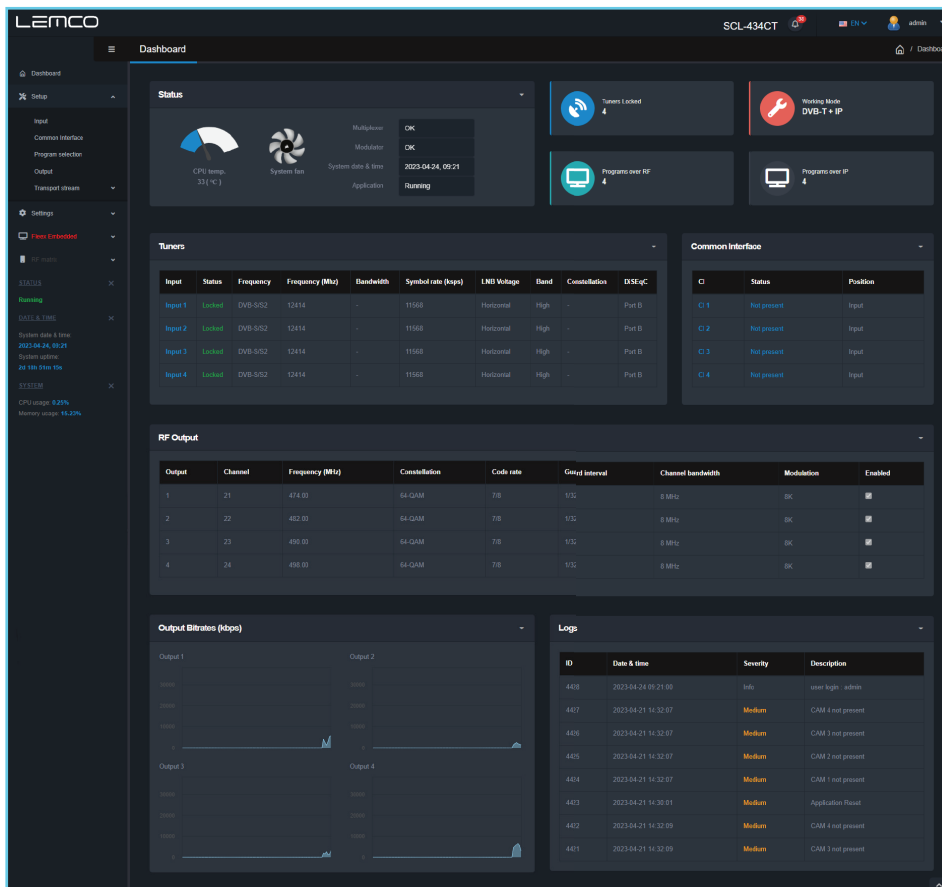

Status

In the Dashboard, users can easily monitor essential aspects of the device's operation, ensuring smooth performance and quick identification of any issues. The information displayed on the Dashboard includes:

1. Device temperature: Keep track of the device's internal temperature to ensure proper cooling and prevent overheating.
2. Fan working status: Monitor the performance of the cooling fans to maintain optimal operating conditions.
3. Multiplexer and Modulator engine status: Check the working status of the device's core components for seamless content processing and distribution.
4. System date and time: Verify the accuracy of the device's internal clock for proper scheduling and event handling.
5. Main application status: Monitor the overall health and functionality of the device's primary software.

Additionally, the Dashboard features four infographics that provide insights into:

1. Tuner lock status: Display the number of tuners currently locked onto a frequency for stable signal reception.
2. Device working mode: Show the operational mode of the device, indicating how it processes and distributes content.
3. Number of TV programs distributed over RF: Display the count of TV programs being transmitted via RF (Radio Frequency) channels.
4. Number of TV programs distributed over IP: Show the count of TV programs being streamed via IP (Internet Protocol) networks.

Tuners:

In this section, users can monitor the working status of all the RF inputs of the device. This includes information on whether they are locked or unlocked, their working mode, and their current settings.

Common Interface:

In this section, users can monitor the status of all the Common Interfaces of the device. This includes information if there is any CAM or not on any CI slot as well as their positions.

RF Output:

This section allows users to view the working status of all the RF outputs of the device, such as the modulator's state, RF output frequencies, and modulation settings.

Output Bitrates:

The device displays the output bitrates of all multiplexers in a chart format, enabling users to quickly assess the data transmission rates for each output.

Logs:

The Logs section provides a record of the last ten event logs, giving users a snapshot of recent device activity and assisting in troubleshooting any issues that may arise.

Status Device

At the bottom of the left menu of the device we've the following information:

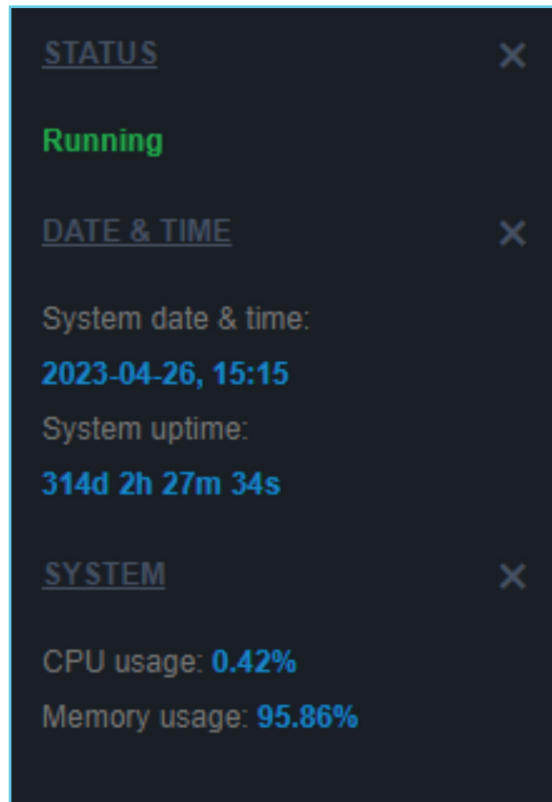

- Status of the software application:
 - Running: The application is running properly
 - Initializing: The application initializes the headend device
 - Stopped: The application has stopped working
- System's current date and time
- System's up time
- CPU and Memory usage by %

Setup

4.2.2 - "Input" page

In the "Input" page, users have the ability to select the working mode for each input:

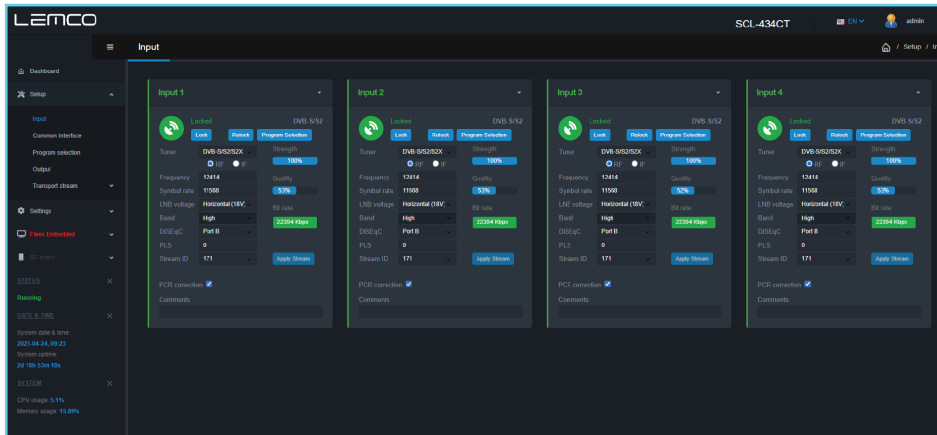

There are four sections, one for each input. Users can configure the working mode of each input using the following field:

Tuner – This field allows users to select the tuner's working mode (DVB-S/S2, DVB-T/T2, DVB-C or Disabled)

For Satellite signal reception the user must select DVB-S/S2 mode from Tuner field and provide the following parameters:

1. RF or IF Radio button – Select frequency input format
2. Frequency – Insert satellite frequency
3. Symbol rate – Insert satellite symbol rate
4. LNB voltage – Select the LNB voltage (13V,18V, OFF)
5. Band – Select the appropriate SAT band (works only if IF frequency is selected as input method)
6. DiSEqC – Select DiSEqC A, B, C, D

For Terrestrial signal reception the user must select DVB-T/T2 mode from tuner field and provide the following parameters:

1. Frequency – Insert the terrestrial input frequency or
2. Channel – Instead of inserting a frequency you can add the channel number
3. Bandwidth – Insert the input channel bandwidth

For DVB-C signal reception the user must select DVB-C mode from tuner field and provide the following parameters:

1. Frequency – Insert the input cable frequency
2. Symbol rate – Insert the symbol rate
3. Constellation – Insert constellation

Once all settings are being written for both tuners, the user must click the "Lock" button to begin the lock process.

More options

PCR correction – Enable / Disable to perform PCR correction of the input stream.

Comments – Text box to add any comments for this specific input.

Tuner status

For each input the SCL-424CT/434CT provides several information such as tuner status (Locked/Unlocked), total bitrate, signal strength, quality etc. as show below:

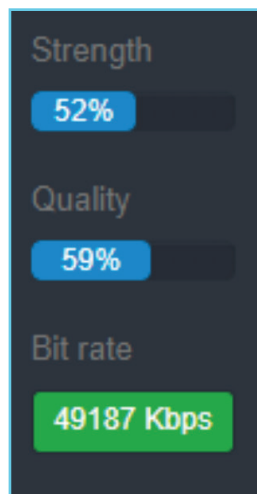

Tuner Status color	Description
Green	The tuner is locked
Yellow	The tuner is unlocked
Red	Error in the tuner
Blue	Tuner is disabled

4.2.3 - "Common Interface" page

At the "Common Interface" page the user is able to setup the CI interfaces according to his needs.

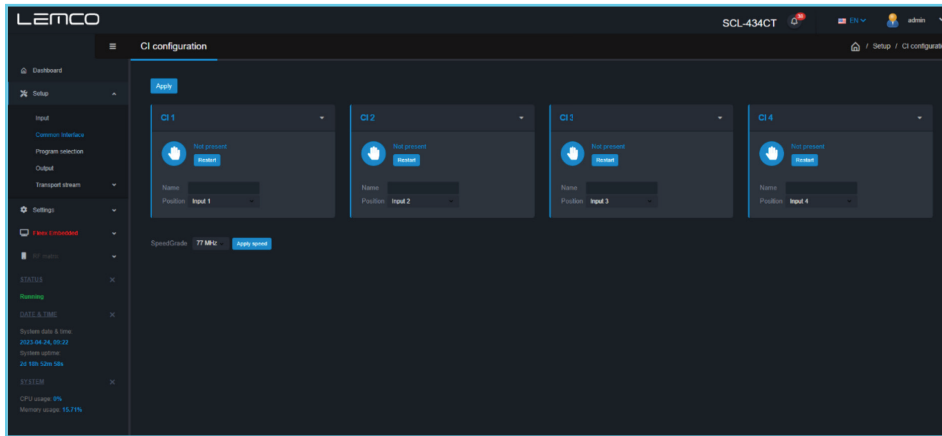

For each CI interface (CI1, CI2, CI3 or CI4) the user is able to select if the CI will be connected at the input or at the output using the "Position" field as follow:

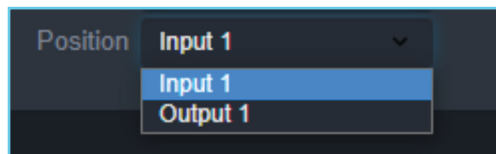

CAM on the input

In case one CAM is selected to be at one input then the CI interface is connected after the tuner and before TS multiplexer. All the TS that is received from the tuner pass through the CI interface and then it enters the TS multiplexer of the device.

In this scenario the user is able to descramble programs coming only from the relevant Input (tuner) Eg. CI 1 will descramble programs coming only from Input No 1.

CAM on the output

In case one CAM is selected to be at one output then the CI interface is connected at the output of the TS multiplexer.

In this scenario the user is able to descramble programs coming from any input Eg. two (2) programs from Input No1 and two (2) programs from Input No2 can be combined in one TS multiplexer's output and then pass through the CAM 1. In this case the CAM 1 will descramble programs coming from both Input No 1 and No2.

Finally, in this page the user is able to select the speed grade for each CI interface between 77MHz or 90MHz. Speed grade selects the clock working speed of the CAM.



4.2.4 - "Program Selection" page

At the "Program Selection" page the user is able to manage all the available TV programs of the device as follows:

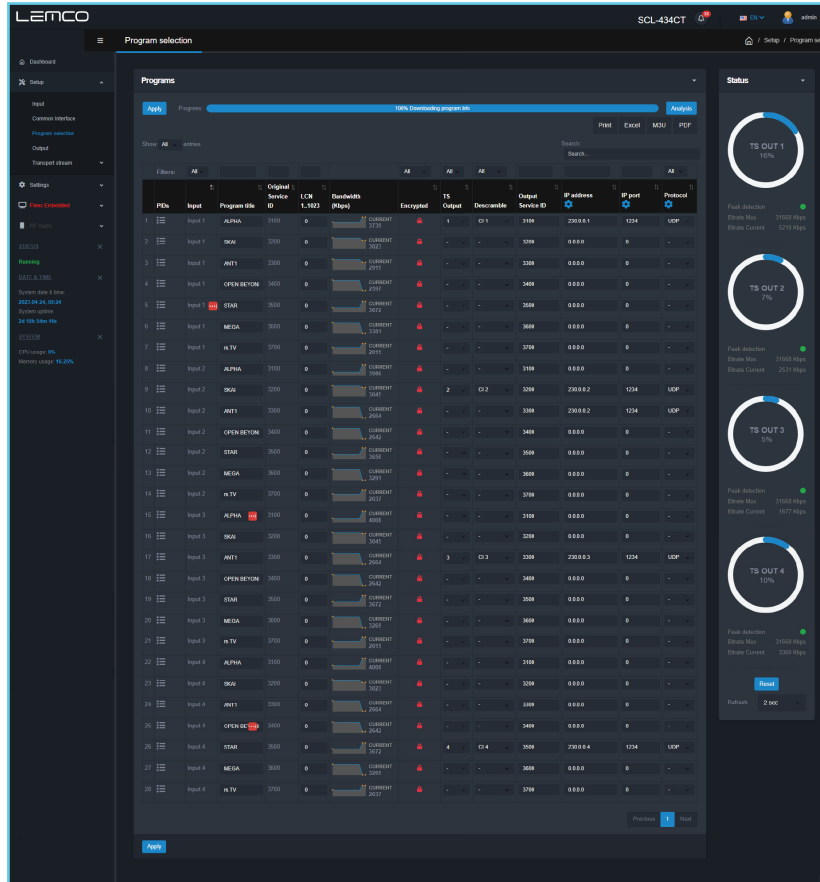

Progress Bar

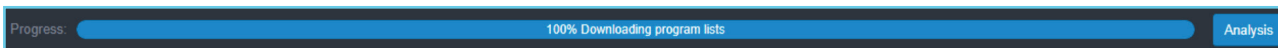

At the top of the page there is a progress bar depicting the analysis status of the multiplexer. When the progress bar is at 100% it means that the multiplexer has successfully finished the analysis of all the available TV/Radio programs of all locked inputs.

The device will display all the available TV/Radio programs that it has detected from all its input that are locked to a DVB-S/S2/T/T2/C frequency.

Export Options

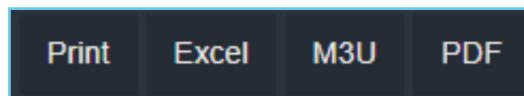

The user is able to print or export the selected TV/Radio programs in Excel, .m3u or pdf file by clicking on the appropriate button.

Search

The headend provides the ability for real-time searching of any program from the list by using the following Search field.

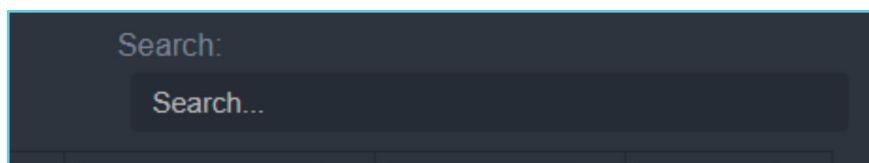

By entering any text in the search field, the list will automatically start to filter and display the available results that match the entered text. This feature allows users to quickly find and sort through the programs or options they are looking for, enhancing the overall user experience and simplifying the process of content management.

TV / Radio programs list table

PIDs	Input	Program title	Original Service ID	LCN 1..1023	Bandwidth (Kbps)	Encrypted	TS Output	Output Service ID	IP address	IP port	Protocol
------	-------	---------------	---------------------	-------------	------------------	-----------	-----------	-------------------	------------	---------	----------

The TV/Radio programs list table provides the following field information for each program:

- PIDs – Submenu for PID filtering (see below)
- Input – Depicts from which input the TV/Radio programs is received
- Program Title – Displays the name of the TV/Radio program. At the same time the user can edit this field to change it.
- Original Service ID – Depicts the original Service ID number
- LCN No – which is the logic channel number of the program
- Bandwidth – which is the bitrate of the program in Kbps
- Encrypted – which depicts if the program is encrypted or not
- TS Output - To select in which multiplexer's output the TV/Radio program will be assigned.
- Output Service ID – The user is able to provide custom Service ID number
- IP address – Set the IP address of the current TV/Radio program for IPTV streaming
- Port – Set the port of the current TV/Radio program for IPTV streaming
- Protocol – Select between UDP/RTP IPTV streaming protocol for the current TV/Radio

* Most of the fields provide Sorting options by using the UP/DOWN arrows

Mass insert function

The IP address, port and Protocol fields offering quick setup by clicking the edit button as follow:

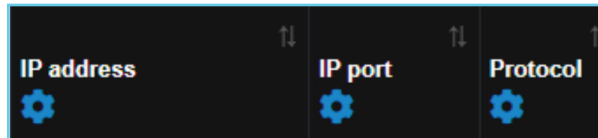

To massively insert IP addresses to selected TV/Radio programs follow the below steps:

1. Sort all the TV/Radio programs by clicking the DOWN arrow at "TS Output" column to sort all the programs that you've selected to output from the device.
2. By clicking the edit button under the title of IP Address column the following pop-up window is displayed:

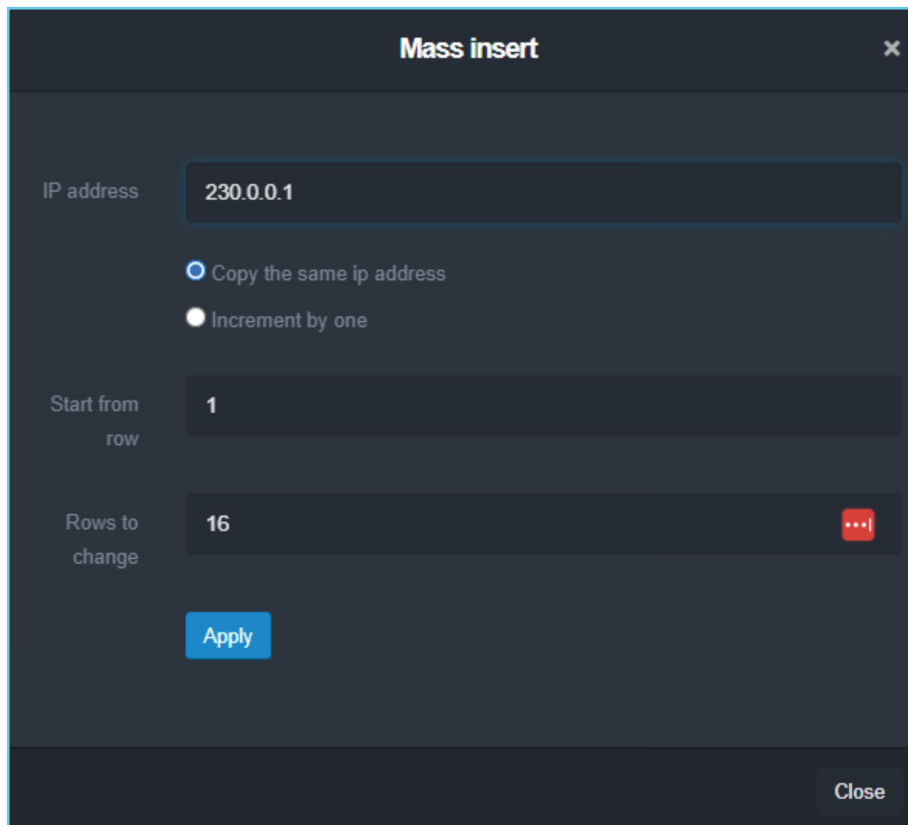

3. In the IP address field insert your starting IP address
4. If you want to copy the same address in all programs, choose the radio button "Copy the same ip address". In case you want to increment by one the last octet of the IP address choose the "Increment by one" option.
5. From the "Start from row" and "Rows to change" fields define from which specific rows the automatic procedure will begin and it will end.
6. And click the "Apply" button.

Repeat the same process for Port and Protocol field.

PID Filtering

At the second column the headend provides the ability to make PID filtering by clicking the "burger" icon  to reveal the available PIDs for each TV/Radio program as show below:

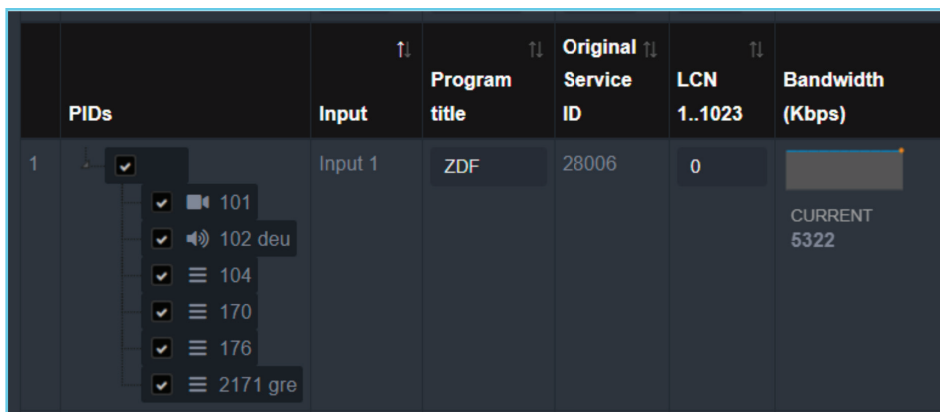

By using the checkboxes, users can easily deselect any PIDs, instructing the headend to filter them out. This feature allows users to manage and control which PIDs are processed and distributed, further enhancing the customization and flexibility of the system according to their specific needs and preferences.

Program Selection

With the drop-down menu in the "TS Output" column, users can easily assign any TV/Radio program to any of the four outputs of the headend. By following the same process for each program, users can create their own custom multiplex for the four output channels. This feature provides a high level of flexibility and customization, allowing users to tailor the headend's output to their specific needs and preferences for content distribution.

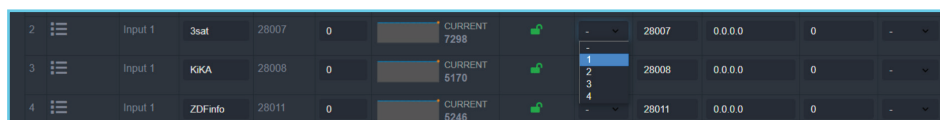

Caution!

The number of programs that the SCL-424CT/434CT is able to distribute depends on the resolution (SD, HD, 4K etc.), the compression (MPEG2, H.264 etc...) and in general from the total bitrate of each program.

For example, if we select the following DVB-T setting for the four modulators on SCL-424CT/434CT outputs:

- Constellation: 64 QAM
- Guard Interval: 1/32
- Code rate: 7/8
- Bandwidth: 8 MHz

We will have a total output bitrate of 31.67Mbps/ modulator. That means that we can select as many programs as the user wants but their total bitrate must not exceed the 31.67Mbps, otherwise artifacts may occur.

CI Selection

At the same time, the user is able to select for each TV/Radio program from which CI the specific program can be descrambled from the "Descramble" field as show below:

PIDs	Input	Program title	ID	1..1023 (Kbps)	Encrypted	Output	Descramble
1	Input 1	ALPHA	3100	0	CURRENT 3739	1	CI 1

Caution!

The "Descramble" field will display the available options based on the CI configuration on "Common Interface" page as described above.

Status

The status section provides a general idea to the user of the current payload (according to the selected programs) comparing it to the max. output payload.

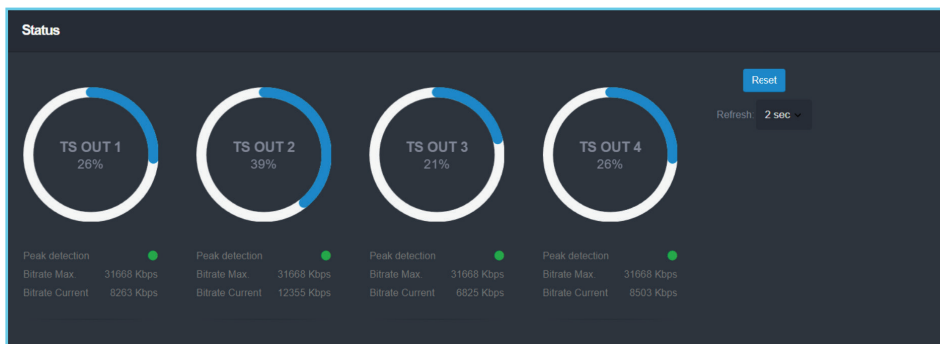

It is recommended that the user must not exceed the 85% from each output, since all the bitrates are variable according to their specific content.

Peak Detection mechanism

As shown above there is a colored indicator of the peak detection mechanism, for each output transport stream. This indicates if any overflow has occurred on modulator's output bitrate with the following colors:

- **Green** – No overflow occurred
- **Yellow** – No overflow occurred but the input bitrate is close to the output bitrate
- **Red** – Overflow occurred. The user must decrease the input bitrate

4.2.5 - "Output" page

On the "RF Output" page, the user can configure the RF output settings for the SCL-424CT/434CT as shown below:

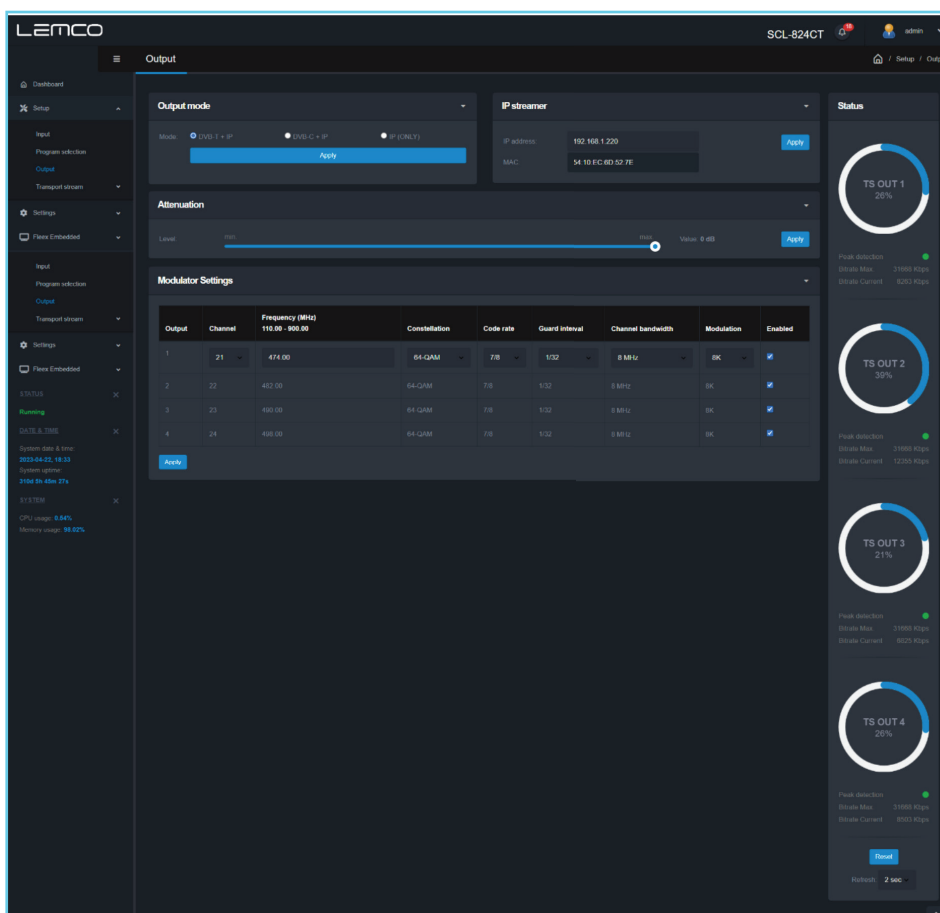

Output Mode

With the use of the radio buttons the user is able to select the mode that the SCL-424CT/434CT will operate as follows:

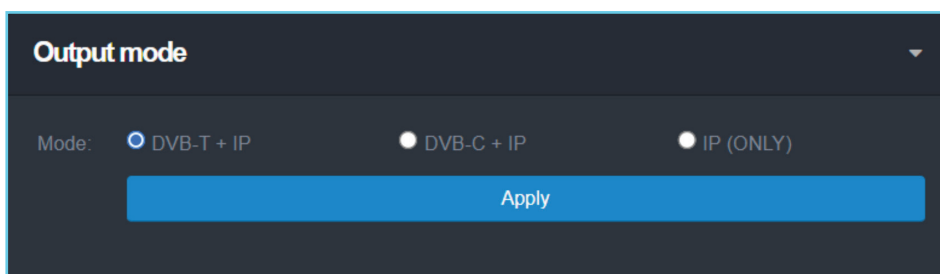

- DVB-T: 4 x modulator working in DVB-T standard + IP streaming
- DVB-C: 4 x modulator working in DVB-C standard + IP streaming
- IP only: All modulators are disabled, the device does IP streaming only

IP streamer

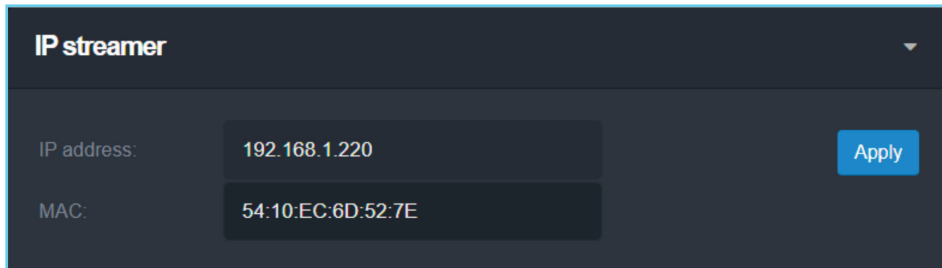

The screenshot shows a configuration window titled "IP streamer". It contains two input fields: "IP address:" with the value "192.168.1.220" and "MAC:" with the value "54:10:EC:6D:52:7E". A blue "Apply" button is located to the right of the IP address field.

The IP streamer section provides the IP address of the headend's streamer that can be used for PING purposes as well as its MAC address.

Attenuation

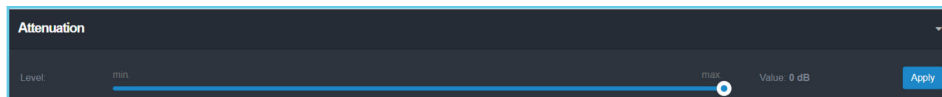

The screenshot shows a configuration window titled "Attenuation". It features a horizontal slider control. The slider has "min" at the left end and "max" at the right end. A white knob is positioned on the slider. To the right of the slider, the text "Value: 0 dB" is displayed. A blue "Apply" button is located to the right of the "Value" text.

The device headend provides an electronic embedded -31.5dB attenuator to provide the ability to the user to increase or decrease the total RF output level of all outputs of the headend at the same time.

Modulator Settings

Output	Channel	Frequency (MHz) 110.00 - 900.00	Constellation	Code rate	Guard interval	Channel bandwidth	Modulation	Enabled
1	21	474.00	64-QAM	7/8	1/32	8 MHz	8K	<input checked="" type="checkbox"/>
2	22	482.00	64-QAM	7/8	1/32	8 MHz	8K	<input checked="" type="checkbox"/>
3	23	490.00	64-QAM	7/8	1/32	8 MHz	8K	<input checked="" type="checkbox"/>
4	24	498.00	64-QAM	7/8	1/32	8 MHz	8K	<input checked="" type="checkbox"/>

For each modulator output in DVB-T mode as the above example the user is able to setup the following parameters:

- Channel – Set the desired output channel in channel format
- Frequency – Set output frequency of the first modulator*
- Constellation – Set the constellation of the first modulator*
- Code Rate – Set the code rate of the first modulator*
- Guard Interval – Set the guard interval of the first modulator*
- Channel Bandwidth – Set the channel bandwidth of the first modulator*
- Modulation – Set the modulation type of the first modulator*
- Enable/Disable – Enable or disable the current modulator

In DVB-C the available fields are the following:

- Frequency – Set output frequency of the first modulator*
- Constellation – Set the constellation of the first modulator*
- Symbol Rate – Set the Symbol rate of the first modulator*
- Frequency Step – Set the frequency step of the first modulator*

* All the four outputs of the SCL-424CT/434CT operate in adjacent RF output channels. This means that the user setups only the first modulator output and all the other three modulators have the same settings and automatically are being programmed in adjacent channels.

E.g. If the user sets the CH21 in UHF band on modulator No1 the other three modulators will be automatically set to CH22, CH23 and CH24, respectively.

Status

The status section provides a general idea to the user of the current payload (according to the selected programs) comparing it to the max. output payload.

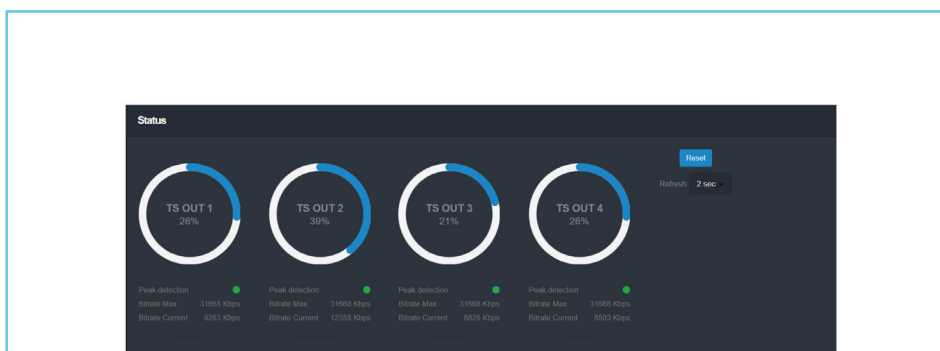

It is recommended that the user must not exceed the 85% from each output, since all the bitrate are variable according to their specific content.

Transport Stream

4.2.6 - "Settings" page

In this section the user is able to setup all the TS settings of the four-output multiplex of SCL-424CT/434CT as shown below:

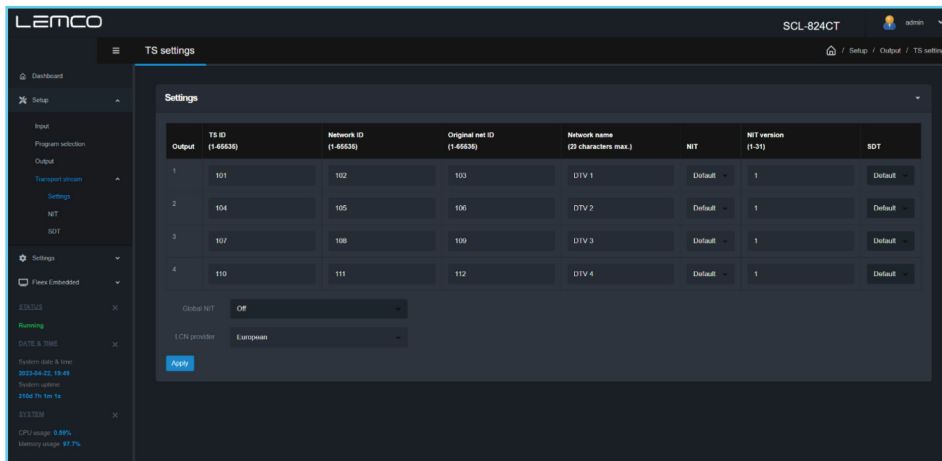

For each multiplex output the user can set the following settings:

TS ID: Which is the ID No of the specific multiplex (1...65535)

Network ID: Which is the Net ID No of the specific multiplex (1...65535)

Original Net ID: Which is the Org. Net ID No of the specific multiplex (1...65535)

Network Name: Which is the network name of the specific multiplex

NIT: Choose from Default, Global and Custom

NIT version: From 1 to 31

SDT: Select Default or Custom

LCN provider: Choose the appropriate LCN provider (EACEM, ITC, Nordig, APN)

4.2.7 - "NIT" page

In this section the user is able to create custom NIT table for each of the four outputs of the device as shown below:

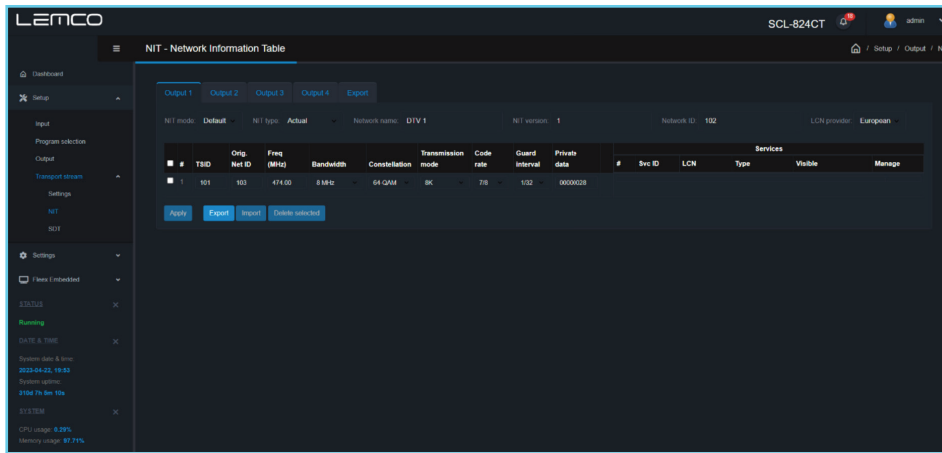

For more information on how to create a custom NIT/SDT table please refer to "Lemco custom NIT/SDT guideline.pdf" document in Lemco's website.

4.2.8 - "SDT" page

In this section the user is able to create custom SDT table for each of the four outputs of the device as shown below:

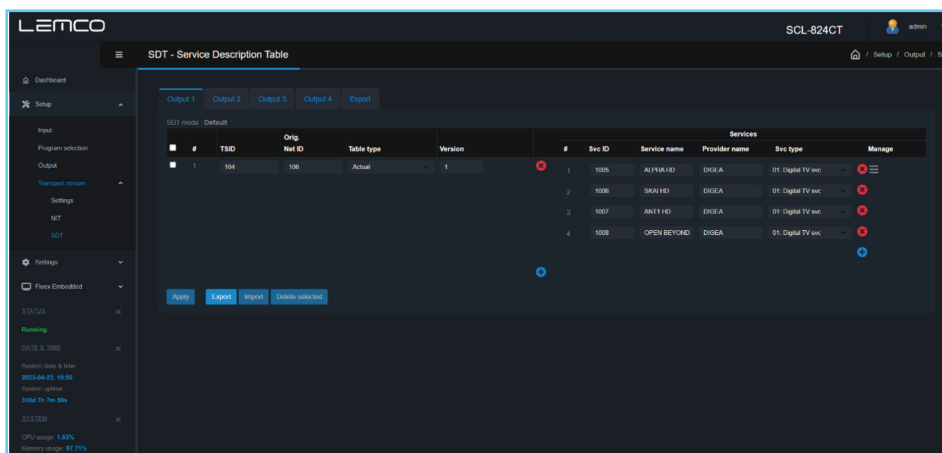

For more information on how to create a custom NIT/SDT table please refer to "Lemco custom NIT/SDT guideline.pdf" document in Lemco's website.

Settings

4.2.9 - "Event log" page

In "Event log" page the system logs all the last one thousand (1000) events occurs in the device during its operation. These logs are divided in three different categories based on their priority as follow:

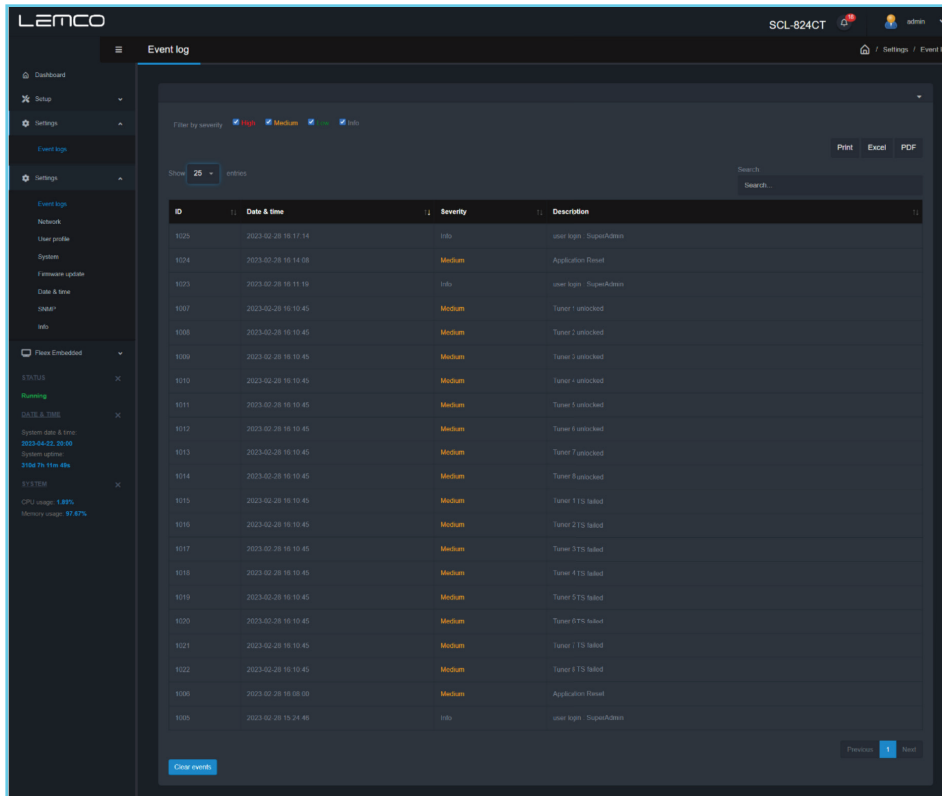

- **High** – With red color the system indicates event logs which are of high priority
- **Medium** – With yellow color the system indicates event logs which are of high priority
- **Low** – With green color the system indicates event logs which are of high priority
- **Info** – With grey color the system indicates event logs which are of high priority

The user has the ability to print or export in excel or pdf file all the selected events.

4.2.10- "Network" page

On the "Network" page, users can set up all the parameters related to the LAN control of the device as follows:

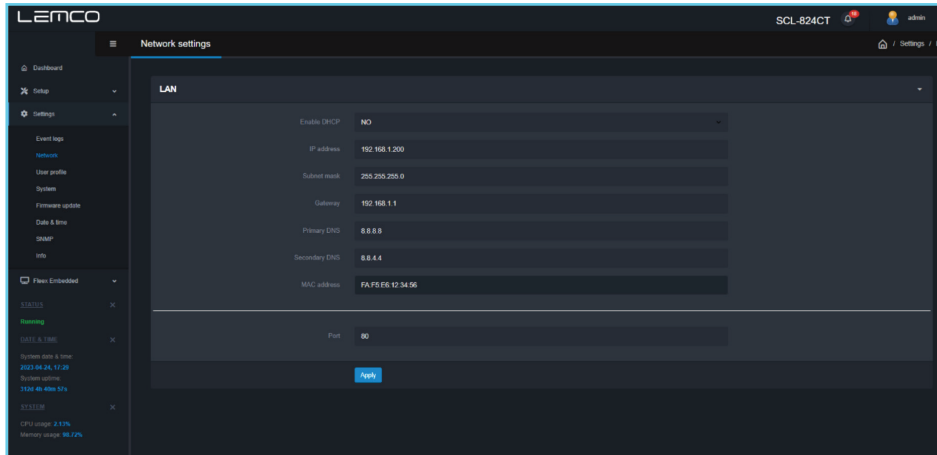

- DHCP – Enable or disable DHCP
- IP address: Set a static IP address for controlling the device
- Subnet mask: Set the specific Subnet mask
- Gateway: Set the gateway's IP address
- Primary DNS: Set the IP address of the primary DNS
- Secondary DNS: Set the IP address of the secondary DNS
- Port: Assign the control port
- MAC address: Depicts the MAC address of the LAN control

Caution!

Port 6060 is used for automatically firmware download from the Lemco cloud server.

4.2.11 - "User profile" page

On "User profile" section the user is able to do the following:

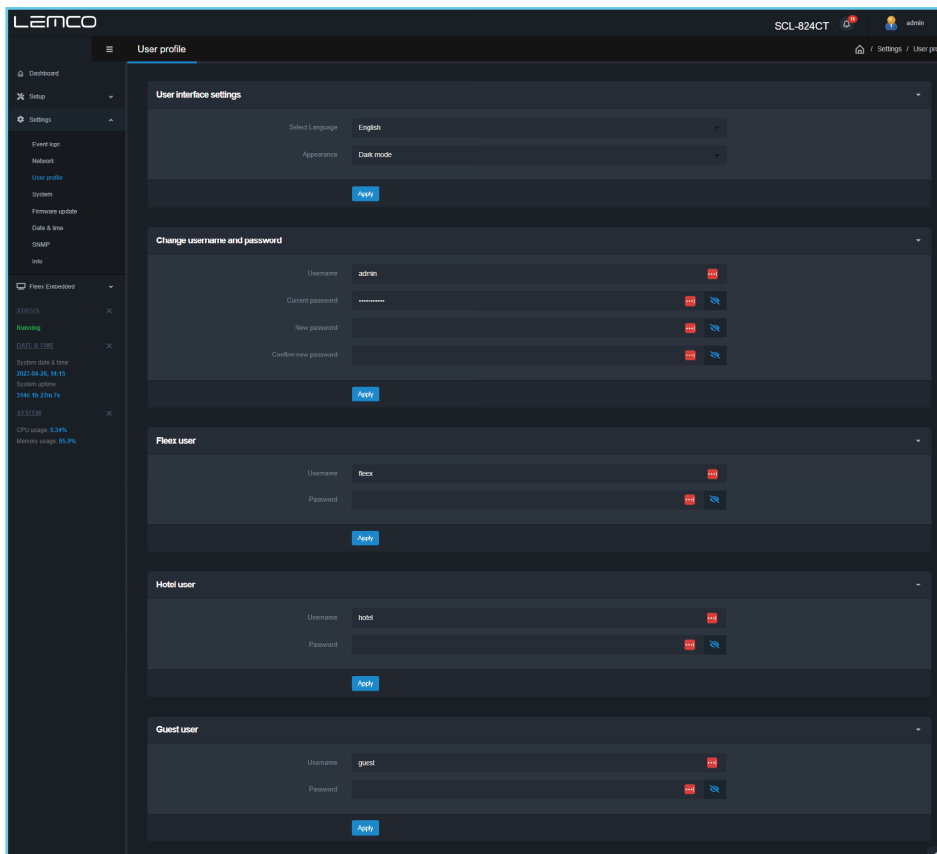

- From the "Select Language" field to select the language of the interface
- From the "Appearance" field to select the Light or dark mode theme.

The device supports several user profiles as follow:

Profile Name	Username	Password	Description
Admin	admin	12345	The user has full read/write privileges to all pages
Fleex	fleex	12345	The user has full read/write privileges only to Fleex section
Hotel	hotel	12345	The user has full read/write privileges only to "Home page" and "Info" page from Fleex Embedded.
Guest	guest	12345	The user has full read privileges

Caution!

- In case of factory default procedure, the username and password will be reset unless the check box "Keep username & password after applying factory defaults" is selected.

4.2.12 - "System" page

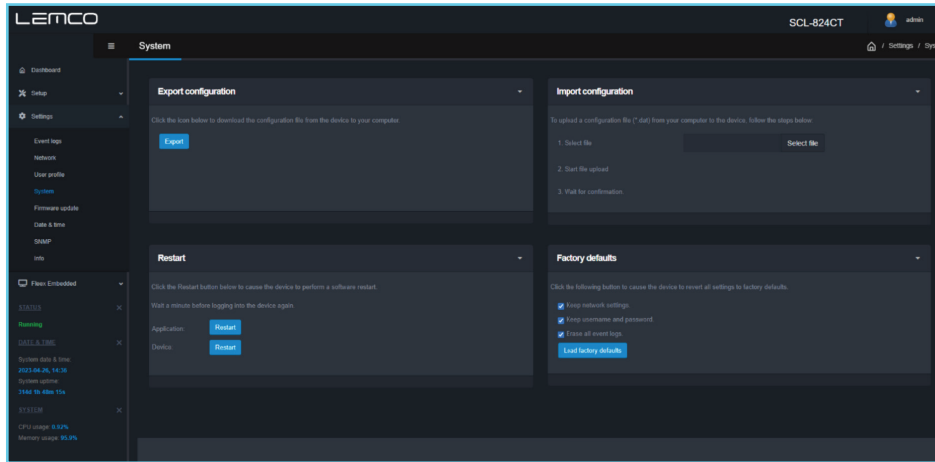

- On system page the user is able to do the following:
 1. Export: Save the headend' s configuration in a specific .dat format file.
 2. Import: Upload a previously saved configuration .dat file to the device
- Apply restart to the application that controls the device or to the whole device.
- Apply a factory default configuration to the device with the following options:

Check Box	Description
Keep network settings	If enabled, the device will keep Network settings upon factory default
Keep username and password	If enabled, the device will keep username and password.
Erase all event logs	If enabled, the device will erase all event logs during factory default procedure.

4.2.13 - "Firmware update" page

On "Firmware update" section the user is able to apply a new firmware update to the device.

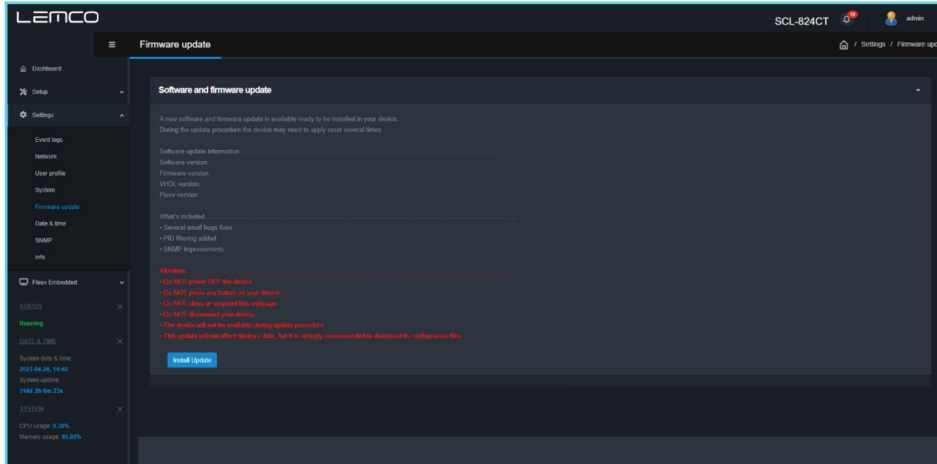

The device automatically downloads the available firmware update from the cloud server and notifies the user that there is a new firmware update. The user by clicking the "Install" button the device does the update automatically and reboots itself...

The whole procedure might take up to 2 min and it does not affect the current configuration of the device.

4.2.14 - "Date & Time" page

On "Date & Time" section the user is able to select the time zone for the device by using the "Timezone" drop down menu:

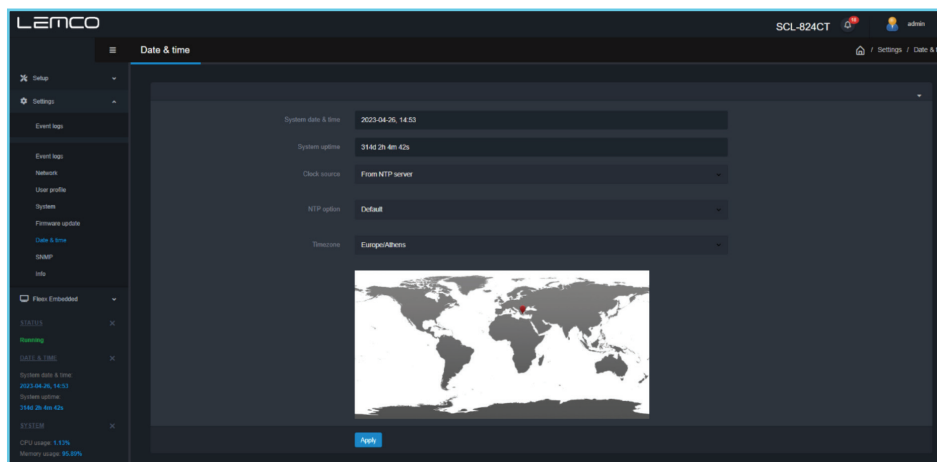

4.2.15 - "SNMP" page

On this section, the user is able to setup the SNMP interface of the device.

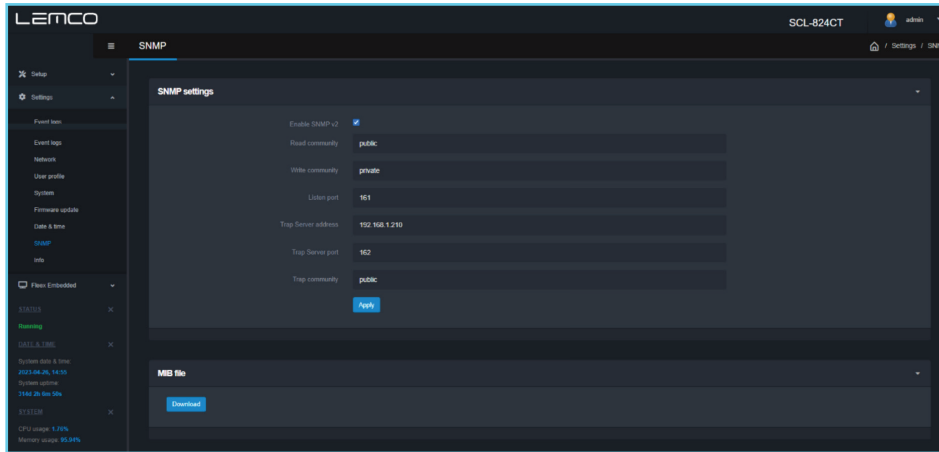

- The device supports SNMP v2
- To use the SNMP client feature of the device a SNMP manager software is required
- To export the .MIB file of the device the user must click the Download button from MIB file section.

4.2.16 - "Info" page

The "Info" page provides information regarding the versions of the following:

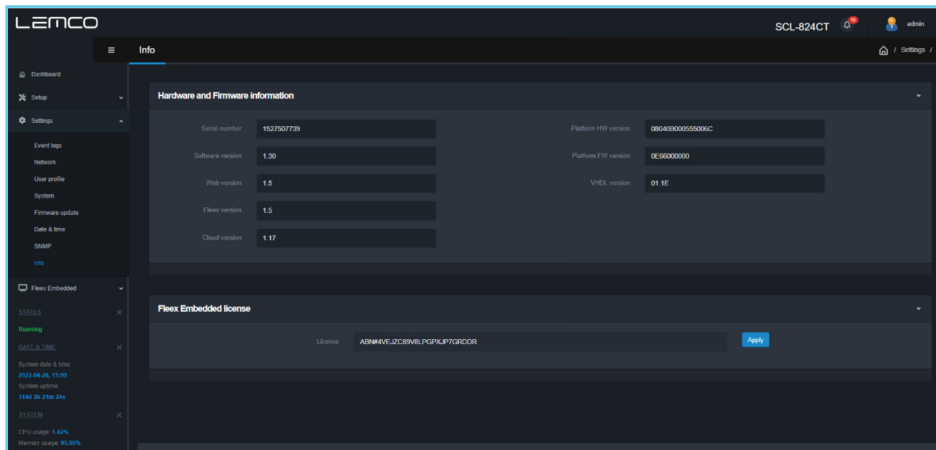

- Software application
- Web version
- Fleex version
- Cloud version
- HW version
- FW version
- VHDL version

Fleex Embedded license

To enable the Fleex Embedded on the specific device the user has to enter the license in the following field and click the "Apply" button:

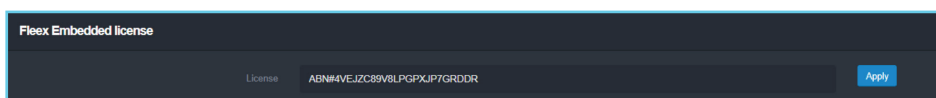

5. TECHNICAL SPECIFICATIONS

Part Number	SCL-424CT GOLD Edition
Description	4 x DVB-S/S2/T/T2/C + 4 x FlexCAM to 4 x DVB-T/C & IP

Input

Type	4 x DVB-S/S2/T/T2/C
Frequencies	950...2150 MHz DVB-S/S2 118...900MHz DVB-T/T2/C
Connector	75Ω - F, female
Loop-through connector	No

LNB

Voltage	OFF / 13V / 18V
Current	Less than 400mA (per input)
22 kHz signal	ON / OFF
22 kHz signal - Voltage	0.65V ± 0.35V
22 kHz signal - Frequency	22 KHz ± 4Hz
22 kHz signal - DiSEqC	1.0 (Port A, B, C, D)

DVB-S (IN)

Symbol rate	1 - 45 MBaud
Roll off factor	0.35
Code rate	1/2, 2/3, 3/4, 5/6, 7/8 (Automatic)
Spectral inversion	Reverse, Non-reverse (Automatic)

DVB-S2 (IN)

Constellation	QPSK, 8PSK (Automatic)
Symbol rate	1 - 45 MBaud (QPSK) - 1 - 30 MBaud (8PSK)
Roll off factor	0.2 / 0.35 (Automatic)
Code rate	1/2, 3/5, 2/3, 3/4, 4/5, 5/6, 8/9, 8/10 (QPSK-Automatic) 3/5, 2/3, 3/4, 5/6, 8/9, 9/10 (8PSK-Automatic)
Spectral inversion	Reverse, Non-reverse (Automatic)

Multi-stream support

T2MI MPLP (multiple PLP) signa	
--------------------------------	--

CI Interface

Number of Common	
Interfaces	4x (in total)
FlexCAM technology	Yes
Connectror	PCMCIA
Max. Frequency	75MHz or 85,70MHz

Compact Line 2 - Headend Series | SCL - 424CT / 434CT

Operation Manual

DVB-T (IN)

Bandwidth	6, 7, 8 MHz
Mode	2K, 8K
Constellation	QPSK, 16QAM, 64QAM
Guard interval	1/4, 1/8, 1/16, 1/32
Code rate	1/2, 2/3, 3/4, 5/6, 7/8

DVB-T2 (IN)

Bandwidth	5, 6, 7, 8 MHz
Mode	1K, 2K, 4K, 8K, 16K, 32K (Included extended mode)
Constellation	QPSK, 16QAM, 64QAM, 256QAM
Code rate	1/2, 3/5, 2/3, 3/4, 4/5, 5/6
Multi PLP support	Yes

DVB-C (Annex A,B,C)

Bandwidth	5, 6, 7, 8 MHz
Mode	Automatic modulation detection
Constellation	16QAM, 32QAM, 64QAM, 128QAM, 256QAM

Transport Stream Processing

Pool technology support	Yes
Services	User selection by service names or Service ID
Automatic regeneration	PAT, CAT, SDT, PMTs, EITs tables
NIT	Pass-through, custom, automatic
Custom NIT/SDT creation	Yes
PCR	Re-stamping
PCR correction	Yes
LCN support	Yes
PID filtering	Yes
EPG information	Yes over RF and IP

RF Output

Type	4 x DVB-T or 4 x DVB-C RF adjacent channels
Output Frequencies	110...900 MHz (10 KHz step)
Output Level	90dB μ V
Connector	75 Ω - F, female
Output Attenuator	0...-30dB

DVB-T (OUT)

Bandwidth	5, 6, 7, 8 MHz
Mode	2K, 8K
Constellation	QPSK, 16QAM, 64QAM
Guard interval	1/4, 1/8, 1/16, 1/32
Code rate	1/2, 2/3, 3/4, 5/6, 7/8
MER	More than 42dB @ Full Band

Compact Line 2 - Headend Series | SCL - 424CT / 434CT

Operation Manual

DVB-C (OUT)

Constellation	16QAM, 32QAM, 64QAM, 128QAM, 256QAM
Symbol rate	2.5-8.4 Ms/s
Channel step	3...10MHz
MER	More than 40dB @ Full Band

IP Streaming (OUT)

IP TS Out	Yes
Protocol	UDP / RTP (Multicast/Unicast)
Speed	1 Gbit (480 Mbps in IP only mode)
Type	Up to 64 x SPTS or 4 x MPTS
SDP/SAP Support	Yes

RF Matrix

RF Matrix Support	Yes, optional
Working frequency	350MHz
Number of TVs	Up to 99 TV monitors
Compatible STB	RFM-002

Programming Interface

Operating system	Linux OS
Ethernet webserver	Yes, embedded webserver
Speed	100/1000 Mbps
Connector	RJ45
Browser compatibility	Chrome, Firefox, Safari, Opera, Edge et al.

EAN-13

Code	5213009761314
------	---------------

General

Power supply	230...240 VAC
Frequency range	50...60Hz
Power supply consumption	~55W
Operating temperature	0 °C to 40 °C
Storage temperature	-10 °C to +70 °C
Humidity	Up to 90%
Dimensions	296.2 x 204.5 x 106mm
Weight	1.70 Kg

5. TECHNICAL SPECIFICATIONS

Part Number SCL-434CT GOLD Edition
Description 4 x DVB-S/S2/S2X + 4 x FlexCAM to 4 x DVB-T/C & IP

Input

Type	4 x DVB-S/S2/S2X
Frequencies	950...2150 MHz
Connector	75Ω - F, female
Loop-through connector	Yes

LNB

Voltage	OFF / 13V / 18V
Current	Less than 400mA (per input)
22 kHz signal	ON / OFF
22 kHz signal - Voltage	0.65V ± 0.35V
22 kHz signal - Frequency	22 KHz ± 4Hz
22 kHz signal - DiSEqC	1.0 (Port A, B, C, D)

DVB-S (IN)

Symbol rate	1 - 45 MBaud
Roll off factor	0.35
Code rate	1/2, 2/3, 3/4, 5/6, 7/8 (Automatic)
Spectral inversion	Reverse, Non-reverse (Automatic)

DVB-S2 (IN)

Constellation	QPSK, 8PSK (Automatic)
Symbol rate	1 - 45 MBaud (QPSK) - 1 - 30 MBaud (8PSK)
Roll off factor	0.2 / 0.35 (Automatic)
Code rate	1/2, 3/5, 2/3, 3/4, 4/5, 5/6, 8/9, 8/10 (QPSK-Automatic) 3/5, 2/3, 3/4, 5/6, 8/9, 9/10 (8PSK-Automatic)
Spectral inversion	Reverse, Non-reverse (Automatic)

DVB-S2X (IN)

Standard	EN302 307-1 V1.4.1
Constellation	QPSK, 8PSK (automatic)
Symbol rate	1 - 45 MBaud (QPSK) / 1 - 30 MBaud (8PSK)
Roll off factor	Από 0.05 to 0.35 (automatic)
Code rate	1/2, 3/5, 2/3, 3/4, 4/5, 5/6, 8/9, 8/10 (QPSK- automatic) 3/5, 2/3, 3/4, 5/6, 8/9, 9/10 (8PSK- automatic)
Multi-stream support	Yes
T2MI MPLP (multiple PLP) signa	Yes

CI Interface

Number of Common Interfaces	4x (in total)
FlexCAM technology	Yes
Connectror	PCMCIA
Max. Frequency	75MHz or 85,70MHz

Transport Stream Processing

Pool technology support	Yes
Services	User selection by service names or Service ID
Automatic regeneration	PAT, CAT, SDT, PMTs, EITs tables
NIT	Pass-through, custom, automatic
Custom NIT/SDT creation	Yes
PCR	Re-stamping
PCR correction	Yes
LCN support	Yes
PID filtering	Yes
EPG information	Yes over RF and IP

RF Output

Type	4 x DVB-T or 4 x DVB-C RF adjacent channels
Output Frequencies	110...900 MHz (10 KHz step)
Output Level	90dB μ V
Connector	75 Ω - F, female
Output Attenuator	0...-30dB

DVB-T (OUT)

Bandwidth	5, 6, 7, 8 MHz
Mode	2K, 8K
Constellation	QPSK, 16QAM, 64QAM
Guard interval	1/4, 1/8, 1/16, 1/32
Code rate	1/2, 2/3, 3/4, 5/6, 7/8
MER	More than 42dB @ Full Band

DVB-C (OUT)

Constellation	16QAM, 32QAM, 64QAM, 128QAM, 256QAM
Symbol rate	2.5-8.4 Ms/s
Channel step	3...10MHz
MER	More than 40dB @ Full Band

IP Streaming (OUT)

IP TS Out	Yes
Protocol	UDP / RTP (Multicast/Unicast)
Speed	1 Gbit (480 Mbps in IP only mode)
Type	Up to 64 x SPTS or 4 x MPTS
SDP/SAP Support	Yes

RF Matrix

RF Matrix Support	Yes, optional
Working frequency	350MHz
Number of TVs	Up to 99 TV monitors
Compatible STB	RFM-002

Programming Interface

Operating system	Linux OS
Ethernet webserver	Yes, embedded webserver
Speed	100/1000 Mbps
Connector	RJ45
Browser compatibility	Chrome, Firefox, Safari, Opera, Edge et al.

EAN-13

Code	5213009761321
------	---------------

General

Power supply	230...240 VAC
Frequency range	50...60Hz
Power supply consumption	~55W
Operating temperature	0 °C to 40 °C
Storage temperature	-10 °C to +70 °C
Humidity	Up to 90%
Dimensions	296.2 x 204.5 x 106mm
Weight	1.70 Kg

6. DIMENSIONS

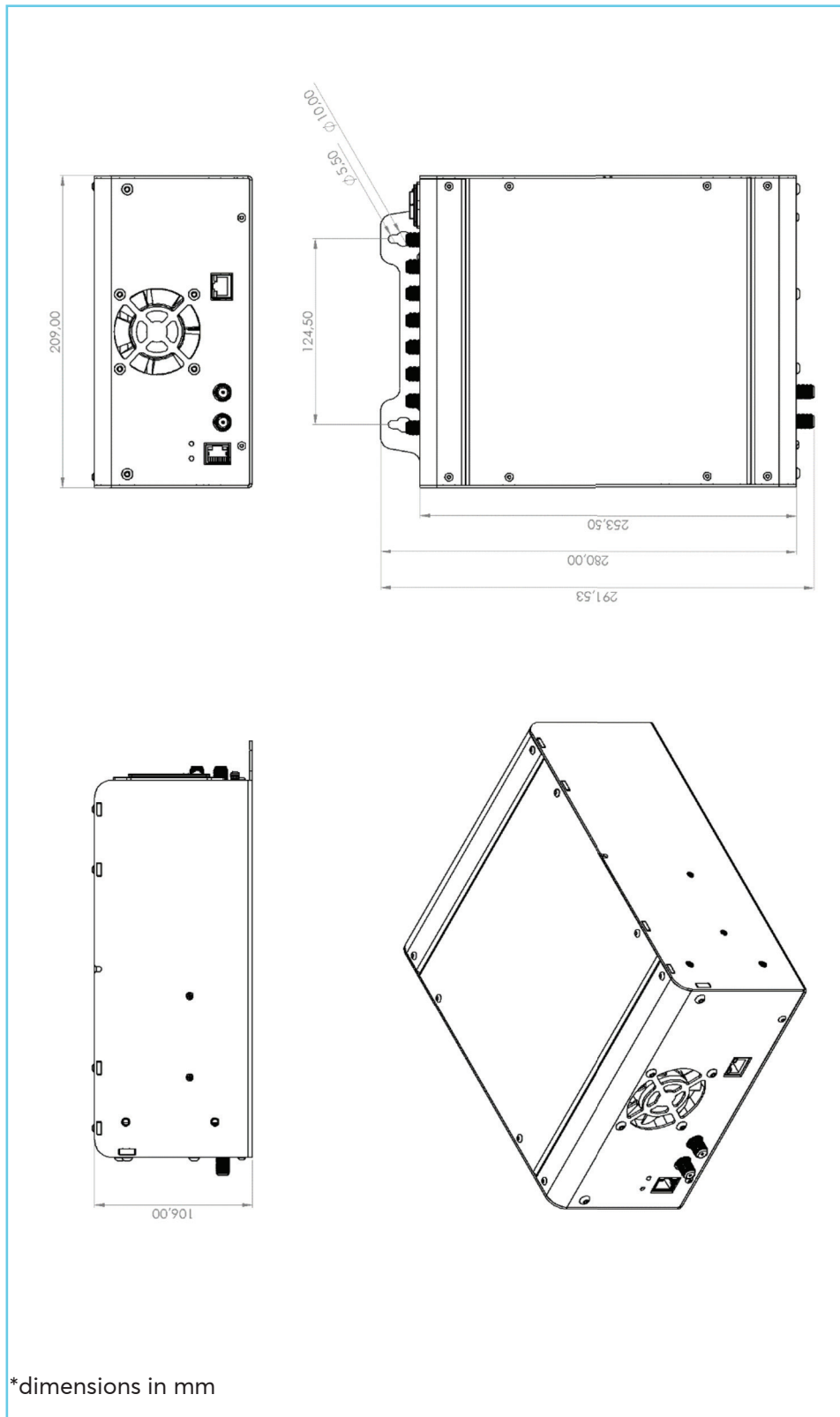

7. WALL MOUNT INSTRUCTIONS

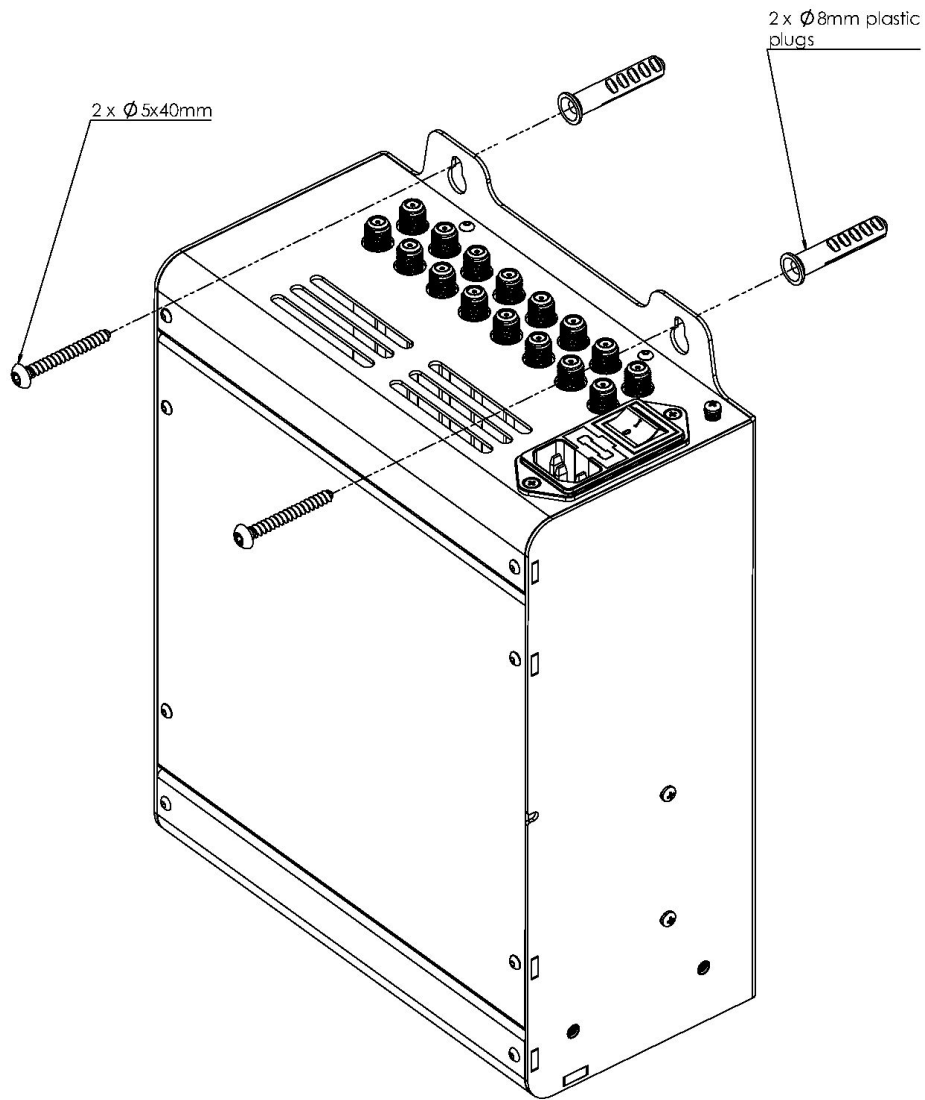

7. LEMCO LIMITED WARRANTY

This device is subject to Lemco Warranty Terms & Conditions that can be downloaded from Lemco's website www.lemco.gr

8. WARNINGS

Content warning

This document contains preliminary information about a product of Lemco company. Lemco reserves the right to make any changes or modifications at any time without prior notice.



Lemco IKE
Address: Latheas 46, 13678, Acharnes, Greece
Tel: +30 210 2811401, +30 210 2405237 - Fax: +30 210 2825755
Email: info@lemco.gr - Website: www.lemco.gr

Follow us:  facebook.com/Lemco

 twitter.com/lemco

 linkedin.com/company/lemco